

Gayada Door

**FIRE RESISTANT
DOORSET SYSTEM**

APPROVED BY



Bomba



SIRIM

DETAILS OF DOORSET - 1 HOUR RATING

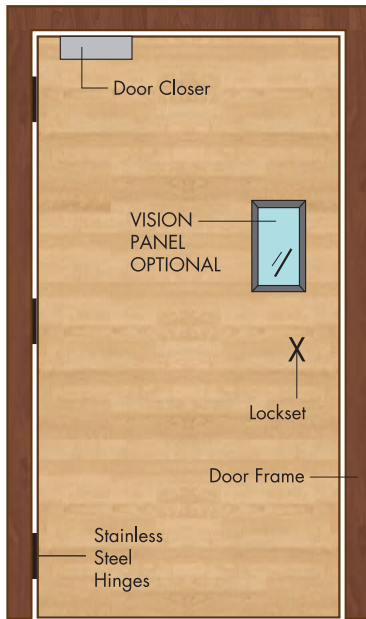

DOOR FRAME SIZE - SINGLE LEAF
(maximum size 1200mm X 2400mm)

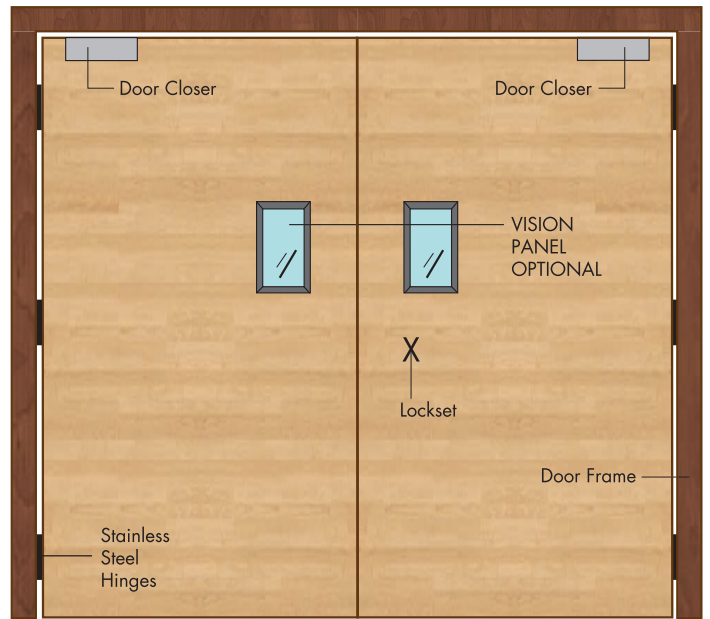

DOOR FRAME SIZE - DOUBLE LEAVES
(maximum size 2400mm X 2400mm)

CROSS SECTION OF DOOR LEAF

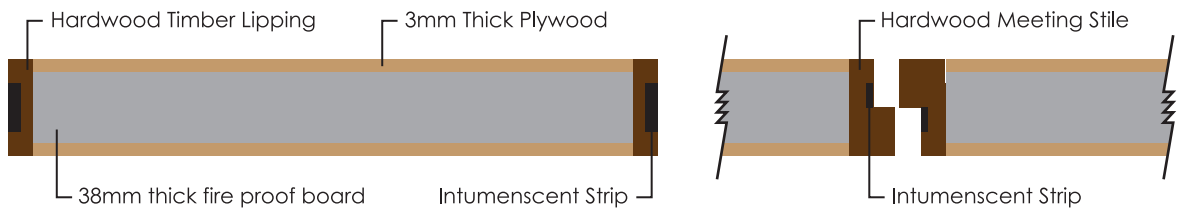

Thickness of Door Leaf ± 44mm

DETAILS OF DOOR FRAME

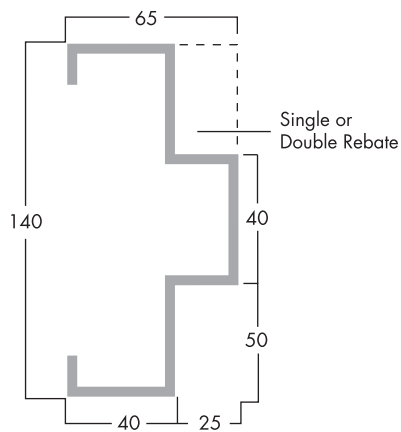

Metal Door Frame

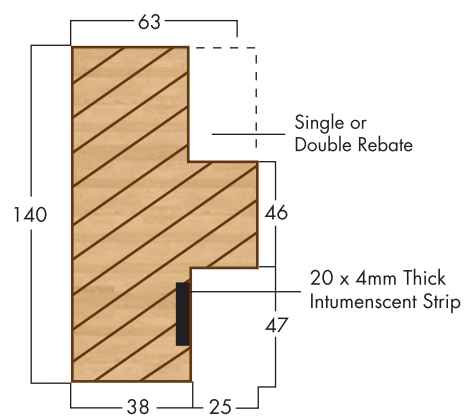

Timber Door Frame

DETAILS OF DOORSET - 2 HOUR RATING

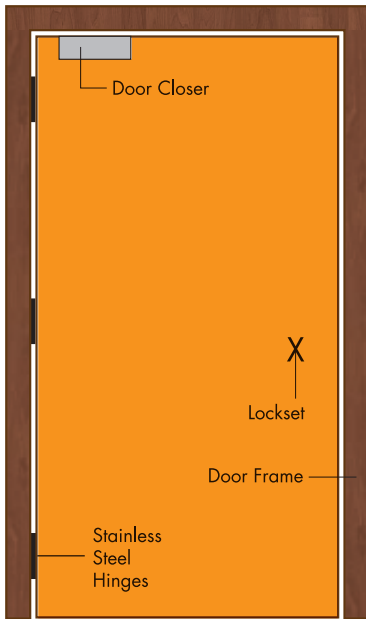

DOOR FRAME SIZE - SINGLE LEAF
(maximum size 1200mm X 2400mm)

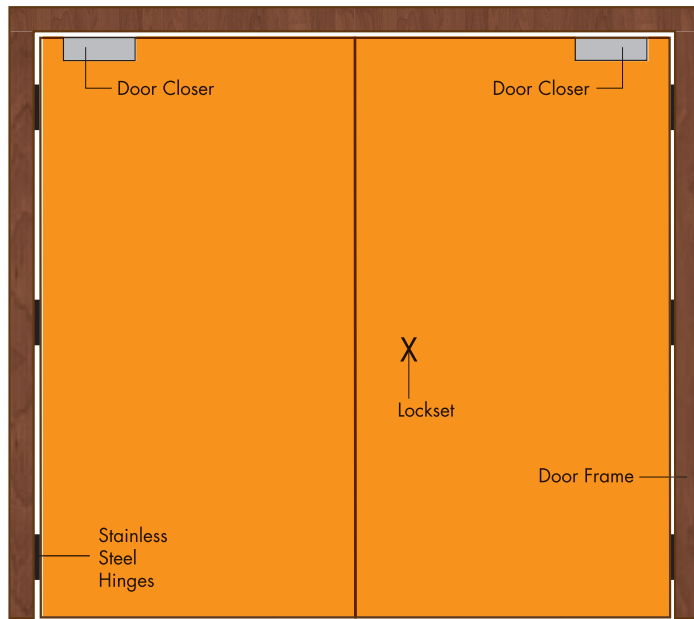

DOOR FRAME SIZE - DOUBLE LEAVES
(maximum size 2400mm X 2400mm)

CROSS SECTION OF DOOR LEAF



Thickness of Door Leaf ± 48mm

DETAILS OF DOOR FRAME

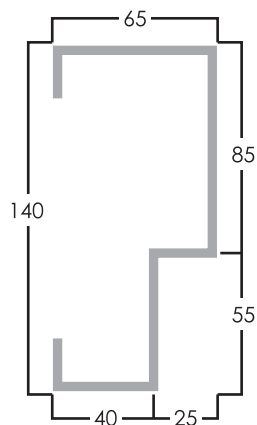

Metal Door Frame (Single Rebate only)



THE TRUSTED NAME IN FIRE DOOR

FEATURE

1-hour rating

GAYADOR 1-hour fire resistant doorset system is constructed from solid core design, fabricated from high performance fire resistant board complete with both sides plywood finish and edged with timber lipping. Overall thickness is $\pm 44\text{mm}$.

The fire rated door frame can either be metal frame of finish size $\pm 65\text{mm} \times 140\text{mm} \times 1.2\text{mm}$ E.G (T) or timber frame of finish size $\pm 63\text{mm} \times 140\text{mm}$ complete with intumescent strip.

The maximum dimension of vision panel is $150\text{mm} \times 300\text{mm}$.

2-hour rating

GAYADOR 2-hour fire resistant doorset system is constructed from solid core design, fabricated from high performance fire resistant board and edged with metal capping. Overall thickness is $\pm 48\text{mm}$.

The fire rated door frame is $\pm 65\text{mm} \times 140\text{mm} \times 1.5\text{mm}$ EG (T)

GAYADOR is tested and approved to the current Malaysian Standard of MS 1073, Part 3: 1996.

GAYADOR offers stable, integrity and insulation features with total commitment for the contemporary construction sector.

MAJOR PROJECT REFERENCES

- Istana Negara, Jalan Duta, Kuala Lumpur
- Renaissance Hotel, Johor
- Putrajaya International Convention Centre
- CIMB Bank Tower, Kuala Lumpur
- Jabatan Peguam Negara, Putrajaya
- Viva Home Mall, Cheras
- The Paradigm, Kelana Jaya
- One Puchong Business Park, Puchong
- Tijani Two North High End Condo, Kuala Lumpur
- Lake City Condominium, Setapak

